

The sample settings below can be used to create different color spectrums in your tank.

10K White						
	Dawn	Sunrise	Midday	Sunset	Dusk	Night
White Channel A	0% @ 6:00AM	80% @ 8:00 AM	100% @ 12:00 PM	100% @ 3:00 PM	80% @ 6:00 PM	0% @ 8:00 PM
Blue Channel B	1% @ 6:00AM	25% @ 7:00 AM	50% @ 10:00 AM	50% @ 3:00 PM	25% @ 6:00 PM	1% @ 8:00 PM
Special Channel C	0% @ 6:00AM	50% @ 8:00 AM	75% @ 12:00 PM	75% @ 3:00 PM	50% @ 6:00 PM	0% @ 8:00 PM

15K White & Blue						
	Dawn	Sunrise	Midday	Sunset	Dusk	Night
White Channel A	0% @ 6:00AM	80% @ 8:00 AM	100% @ 12:00 PM	100% @ 3:00 PM	80% @ 6:00 PM	0% @ 8:00 PM
Blue Channel B	1% @ 6:00AM	80% @ 7:00 AM	100% @ 10:00 AM	100% @ 3:00 PM	80% @ 6:00 PM	1% @ 8:00 PM
Special Channel C	0% @ 6:00AM	50% @ 8:00 AM	75% @ 12:00 PM	75% @ 3:00 PM	50% @ 6:00 PM	0% @ 8:00 PM

20K Heavy Blue						
	Dawn	Sunrise	Midday	Sunset	Dusk	Night
White Channel A	0% @ 6:00AM	25% @ 8:00 AM	50% @ 12:00 PM	50% @ 3:00 PM	25% @ 6:00 PM	0% @ 8:00 PM
Blue Channel B	1% @ 6:00AM	80% @ 7:00 AM	100% @ 10:00 AM	100% @ 3:00 PM	80% @ 6:00 PM	1% @ 8:00 PM
Special Channel C	0% @ 6:00AM	50% @ 8:00 AM	75% @ 12:00 PM	75% @ 3:00 PM	50% @ 6:00 PM	0% @ 8:00 PM

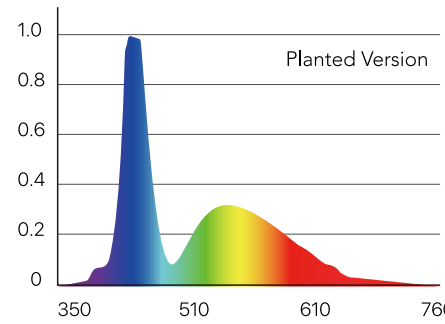
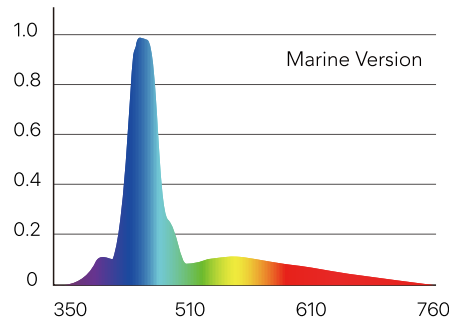
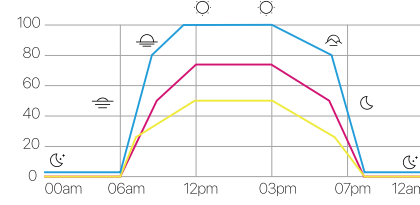
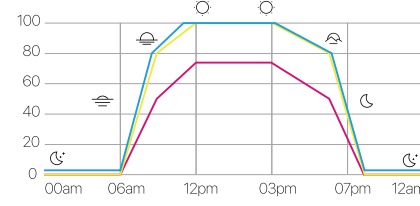
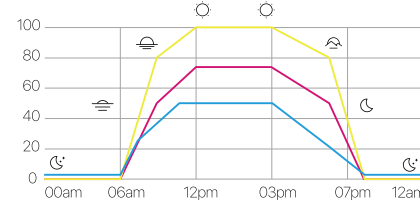

Lighting Compare

Aqua Air 300	Aqua Air 600	Aqua Air 900	Aqua Air 1200
Power: 24W Size: 280X126X11mm Weight: 1.5kg Packing: 450x170x50mm	Power: 48W Size: 560X126X11mm Weight: 2.0kg Packing: 840x170x50mm	Power: 72W Size: 860X126X11mm Weight: 2.5kg Packing: 1010x170x50mm	Power: 96W Size: 1160X126X11mm Weight: 3.0kg Packing: 1300x170x50mm
Marine: 20pcs White Channel A - White 8pcs Blue Channel A - White 28pcs Royal Blue Channel B - Blue 2pcs Blue Channel C - Special 2pcs W White Channel C - Special 2pcs UV Channel C - Special 1pc Red Channel C - Special 1pc Green Channel C - Special	Marine: 40pcs White Channel A - White 16pcs Blue Channel A - White 56pcs Royal Blue Channel B - Blue 4pcs Blue Channel C - Special 4pcs W White Channel C - Special 4pcs UV Channel C - Special 2pc Red Channel C - Special 2pc Green Channel C - Special	Marine: 60pcs White Channel A - White 24pcs Blue Channel A - White 84pcs Royal Blue Channel B - Blue 6pcs Blue Channel C - Special 6pcs W White Channel C - Special 6pcs UV Channel C - Special 3pc Red Channel C - Special 3pc Green Channel C - Special	Marine: 80pcs White Channel A - White 32pcs Blue Channel A - White 112pcs Royal Blue Channel B - Blue 8pcs Blue Channel C - Special 8pcs W White Channel C - Special 8pcs UV Channel C - Special 4pc Red Channel C - Special 4pc Green Channel C - Special
Planted: 28pcs White Channel A - White 20pcs White Channel B - Blue 8pcs Blue Channel B - Blue 2pcs Blue Channel C - Special 2pcs W White Channel C - Special 2pcs UV Channel C - Special 1pc Red Channel C - Special 1pc Green Channel C - Special	Planted: 56pcs White Channel A - White 40pcs White Channel B - Blue 16pcs Blue Channel B - Blue 4pcs Blue Channel C - Special 4pcs W White Channel C - Special 4pcs UV Channel C - Special 2pc Red Channel C - Special 2pc Green Channel C - Special	Planted: 84pcs White Channel A - White 60pcs White Channel B - Blue 24pcs Blue Channel B - Blue 6pcs Blue Channel C - Special 6pcs W White Channel C - Special 6pcs UV Channel C - Special 3pc Red Channel C - Special 3pc Green Channel C - Special	Planted: 112pcs White Channel A - White 80pcs White Channel B - Blue 32pcs Blue Channel B - Blue 8pcs Blue Channel C - Special 8pcs W White Channel C - Special 8pcs UV Channel C - Special 4pc Red Channel C - Special 4pc Green Channel C - Special
Bracket Dimensions (length): Min tank: 325mm Max tank: 565mm	Bracket Dimensions (length): Min tank: 585mm Max tank: 1085mm	Bracket Dimensions (length): Min tank: 885mm Max tank: 1385mm	Bracket Dimensions (length): Min tank: 1185mm Max tank: 1685mm

Information

WARNING: Never put the light and the smart controller in the water. Doing so may be dangerous and damage your light.

Important Handling Information

NOTICE: Failure to follow these handling instructions could result in damage to your Aqua Air or other property.

Carrying your Aqua Air before you move your Aqua Air, shut it down and disconnect all cables and cords connected to it. Using power cord Never force a connector into a port. Don't put the power cord into your tank when it connected. When you Setup your Aqua Air please make sure that it locate power supply where it will not be exposed to any water or moisture.

Mount your power supply where it won't get wet. Include a "drip loop" - a tied loop of cord hanging down below the level of the electrical outlet. That way, if water happens to run down the cord from the tank, it will drip off onto the floor rather than into the outlet. Drip Loops should always be used to help prevent water from traveling along the cord and coming into contact with an electrical outlet. Drip loops must always be below the level of the outlet. If the plug or outlet does get wet, DO NOT TOUCH the cord.

Storing your Aqua Air If you are going to store your Aqua Air for an extended period of time, keep it in a cool location (ideally, 71° F or 22° C).

When cleaning the outside of your Aqua Air, first shut down your Aqua Air and unplug the power cord. Then use a damp, soft, lint-free cloth to clean the lamp exterior. Avoid getting moisture in any openings. Do not spray liquid directly on the lamp. Do not use aerosol sprays, solvents, or abrasives that might damage the finish.

MicMol and the Environment

MicMol recognizes its responsibility to minimize the environmental impact of its operations and products.



Warranty

MicMol warrants all MicMol products to be free from manufacturing defects for one year from the original purchase date when purchased through an authorized MicMol retailer. This warranty does not cover any damages caused by misuse, neglect, alterations or improper handling / transport / maintenance / installation. Physical damages are not covered by warranty. MicMol does not cover personal injury, personal loss, or other damages associated with the use of our products. In order to request warranty service, please email us at support@micmol.com. A purchase receipt is required for any warranty service. Products requiring warranty service must be returned to MicMol or authorized MicMol retailer. You are responsible for the cost of shipping a warranty claim to MicMol and any damages that may occur during transit. Once a returned product has been inspected, it will be repaired or exchanged at our discretion and returned to you. Thank you very much.

Aqua Air Overview

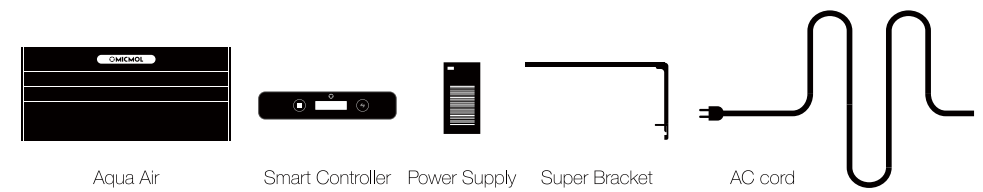

Getting Started

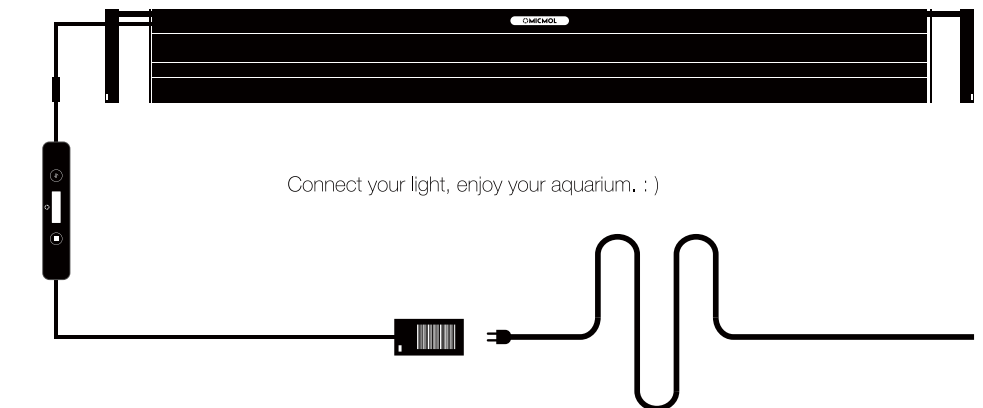

© 2012~2019 MicMol Limited. All rights reserved.
 MicMol, the MicMol logo, Aqua mini, Aqua Pro, Aqua Air, Aqua CC, BloomBee are trademarks of MicMol registered.
 AA006-1711-A Printed in China



AQUA Air Series

Congratulations on purchasing your Aqua Air.
Read this guide to get started to installing your lighting.

How to install the bracket. (Standard)

Overview the bracket.

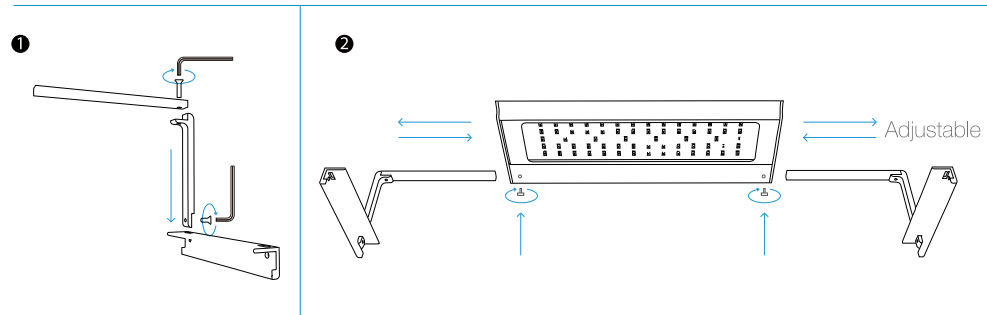
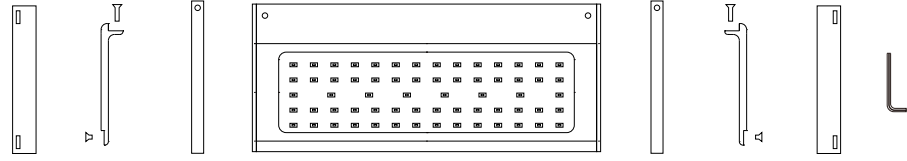

How to install the hanging kits. (Optional)

Overview Hanging Kits

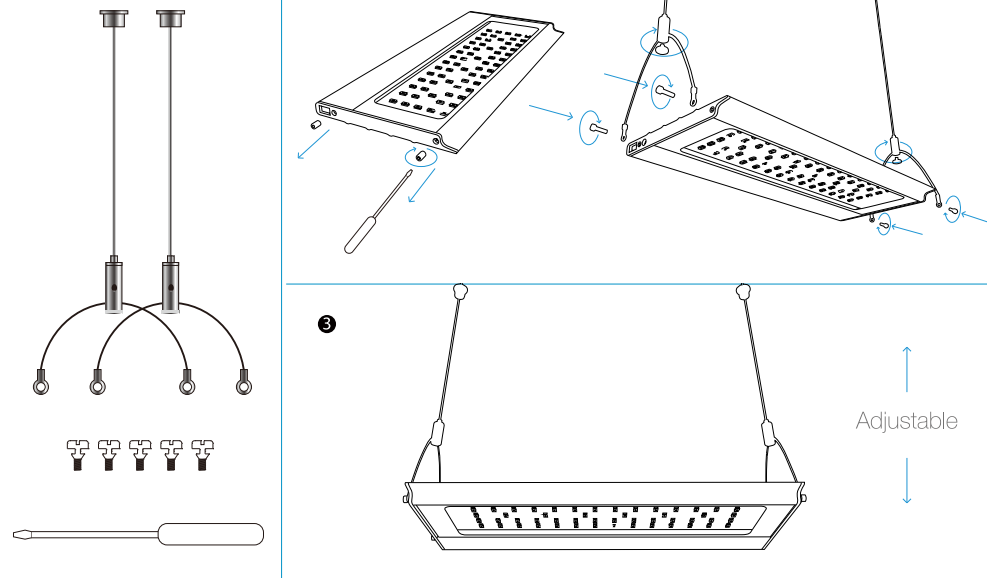

How to connect two Aqua Air. (Optional)

Overview connector

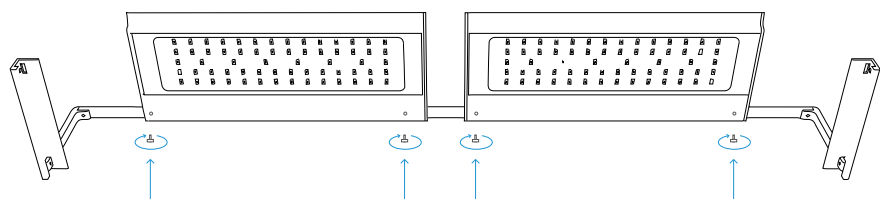

Smart Controller Setup

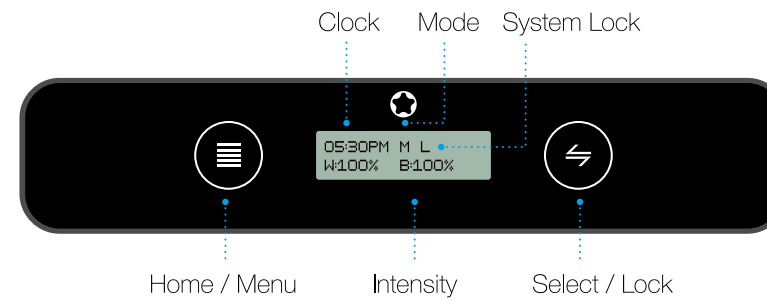

Home / Menu - Browse menu.
Special Function 1 : Hold on 3 second to return to the previous menu.
Special Function 2 : Hold on 3 second under locked to switch Auto & Manual mode.

Select / Adjust - Enter the sub-menu to adjust the parameters.
Special Function 1: Hold on 3 second to unlock system.
Special Function 2: Hold on 3 second to lock system.

	Auto Mode		Manual Mode	
Systems Loadings IMOS 3.0M	05:30PM A L W:060% B:060%	05:30PM A LT S:030%	05:30PM M L W:100% B:100%	05:30PM M LT S:100%
Boot screen	Home screen 1	Home screen 2	Home screen 1	Home screen 2

Note: "A" = Auto Mode, "M" = Manual Mode, "L" = Locked, "LT" = Lightning ON.

Setting Up Your Aqua Air now.

1) Set Clock

- Hold **Select/Lock** for 3 seconds to unlock controller
- Press **Home/Menu** to enter main menu
- Press **Home/Menu** to toggle through options
- Press **Select/Lock** to select 1) Set Clock menu
- Press **Select/Lock** to adjust time.
- Press **Home/Menu** to toggle through options
- Press **Home/Menu** to return to main menu

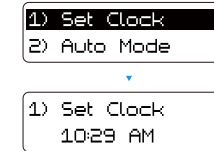

2) Auto Mode - Set LEDs (e.g: Set White Channel)

- Hold **Select/Lock** for 3 seconds to unlock controller
- Press **Home/Menu** to enter main menu
- Press **Home/Menu** to toggle through options
- Press **Select/Lock** to select 2) Auto Mode menu
- Press **Select/Lock** to select Set White menu
- Press **Select/Lock** to adjust Dawn time.
- Press **Home/Menu** to toggle through options
- Press **Home/Menu** to select Intensity
- Press **Select/Lock** to adjust Intensity.
- Press **Home/Menu** to toggle through options
- Press **Home/Menu** to move to next setpoint
- Repeat Steps 5-9 for Sunrise, Midday, Dusk and Night
- Press **Home/Menu** to return to main menu

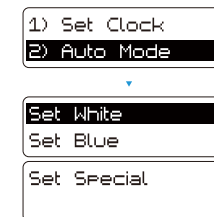

Dawn	06:00 AM	Intensity	001%
Sunrise	07:00 AM	Intensity	050%
Midday	12:00 PM	Intensity	100%
Sunset	03:00 PM	Intensity	100%
Dusk	07:00 PM	Intensity	050%
Night	10:00 PM	Intensity	001%

Auto Mode (Set Blue & Special Channel)

Set the Blue Channel and Special Channel which is same as the White Channel operate step.



3) Manual Mode

- Press **Select/Lock** to select 3) Manual Mode menu
- Press **Home/Menu** to adjust Enable Manual Mode > Yes/No
- Press **Select/Lock** to enter the channel selection list
- Press **Home/Menu** to select the White, Blue, Special Channel
- Press **Select/Lock** to adjust Intensity for each channel
- Press **Home/Menu** to return to main menu

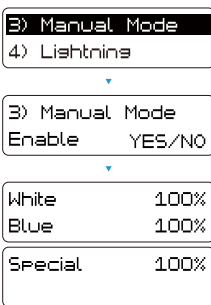

4) Lightning

The advanced settings allow you to control the time period storms will occur in a 24 hour period, the number of storms during this set time and the frequency at which a storm period is activated.

- Hold **Select/Lock** for 3 seconds to unlock controller
- Press **Home/Menu** to enter main menu
- Press **Home/Menu** to toggle through options
- Press **Select/Lock** to select 5) Set Lightning menu
- Press **Select/Lock** to adjust Enable Lightning > Yes/No
- Press **Home/Menu** to set Start/End Hour
- Press **Select/Lock** to adjust Start/End Hour.
- Press **Home/Menu** to enter next menu
- Press **Home/Menu** to set Per Day and Frequency
- Press **Select/Lock** to adjust Per Day
- Press **Home/Menu** to set Frequency
- Press **Select/Lock** to adjust Frequency
- Press **Home/Menu** to return to main menu

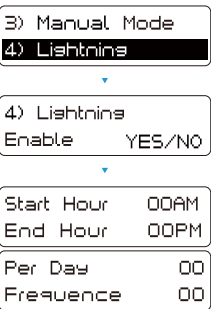

5) Demo

- Press **Home/Menu** button to enter main menu
 - Press **Home/Menu** button to select 5) DEMO
 - Press **Select/Lock** button to select YES
- Note: The DEMO will show all your settings in 1 minute.

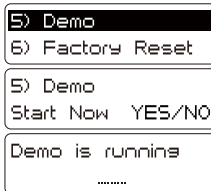

6) Factory Reset

- Press **Home/Menu** button to enter main menu
- Press **Home/Menu** button to select 6) Factory Reset
- Press **Select/Lock** button to select YES
- Press **Home/Menu** button to set Factory Reset

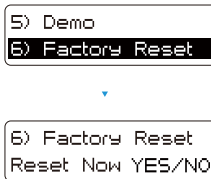

The Control system will gradually ramp the intensity of LED between set points.
The graph below outlines how the LEDs will ramp up and down between settings.

